

User Manual

Solar Pumping Inverter

JNP22KH-V5

JNP30KH-V5

JNP37KH-V5

JNP45KH-V5

JNP55KH-V5

JNP55KH-V5-EN-V1.1

The copyright belong to Supplier.

This document involves the proprietary and confidential information about Solar pumping inverter of Supplier. It strictly prohibited to disclose the document by duplicating, photocopying, publishing online and in other forms without the company's permission.

Supplier. reserves the right to change details in this publication without notice.

Preface

Manual Instruction

This manual describes the transportation, installation, operation, maintenance and troubleshooting of the following JNP inverters:

- JNP22KH-V5
- JNP30KH-V5
- JNP37KH-V5
- JNP45KH-V5
- JNP55KH-V5

In order to describe conveniently later, JNP22KH-V5, JNP30KH-V5, JNP37KH-V5, JNP45KH-V5, JNP55KH-V5 will be short for JNPxH, solar pumping inverter will be short for inverter. The inverter type shall be pointed alone, when introduce the information about each type of inverter in details.

Target Reader

This manual applies to the professional engineering and technical person who is responsible for installing and operating of inverter and LCD panel.

Use the Manual





Please read this manual carefully before installing and operating inverter.

Please keep this manual well for operation and maintenance in future.







The manual content would be constantly updated and revised, but it unavoidably has slightly discrepancies or errors with real inverter, please kind prevail if user purchases our inverter.



Symbol Used

The following safety symbols may be used in this manual, and the meanings are shown in below.

Safety Symbol	Meaning
 Danger!	Means that it may lead to serious accident of injuries, if safety warning is ignored.
 Warning!	Means that it may lead to serious accident of injuries, equipment serious damage or main business interruption, if safety warning is ignored.
 Notice!	Means that it may lead to moderate accident of injuries, equipment moderate damage or part of the business interruption, if safety warning is ignored.
 Note!	Means that the content is additional information.

Inverter related symbols:

Symbol	Meaning
	Direct current (DC)
	Alternating current (AC)
	Protective grounding
	Refer to relevant instructions
	Can not discard inverter together with domestic garbage
	Beware of dangerous high-voltage.

	<p>Should wait for 5 minutes after inverter and PV panel are disconnected, then inverter only can be touched.</p>
	<p>Beware of hot surface The inverter temperature can exceed 60 °C during operation. Please don't touch the surface to avoid scald.</p>
	<p>CE certification marks. It means that inverter complies with the requirement of CE certification.</p>

CONTENT

PREFACE.....	III
MANUAL INSTRUCTION.....	III
TARGET READER.....	III
USE THE MANUAL.....	III
SYMBOL USED.....	III
1 SAFETY INSTRUCTIONS.....	9
2 PRODUCT PRESENTATION.....	14
2.1 INTRODUCTION TO PV PUMP INVERTER.....	14
2.2 PRODUCT INTRODUCTION.....	17
2.2.1 <i>Product appearance</i>	17
2.2.2 <i>Production Dimensions</i>	18
2.2.3 <i>Product Name</i>	19
3 INVERTER UNPACKING.....	20
3.1 UNPACKING CHECK.....	20
3.2 IDENTIFY INVERTER.....	21
4 INSTALLATION PROCEDURE.....	24
4.1 PREPARE INSTALLATION TOOLS.....	24
4.2 INSTALLATION STEPS.....	25
5 INSTALLATION.....	26
5.1 INSTALLATION SITE REQUIRED.....	26

5.2	INSTALLATION DIRECTION.....	27
5.3	INSTALLATION OF INVERTER.....	28
6	ELECTRICAL CONNECTION.....	31
6.1	CONNECTING TERMINALS OF INVERTER.....	32
6.2	SCHEMATIC DIAGRAM OF ELECTRICAL CONNECTION.....	33
6.3	CABLE SELECTION.....	34
6.4	AC SIDE ELECTRICAL CONNECTION.....	34
6.5	DC SIDE CONNECTION.....	38
6.6	WATER LEVEL SENSOR CONNECTION.....	40
	6.6.1 <i>Water level sensor interface define</i>	41
	6.6.2 <i>Water level sensor connection</i>	42
6.7	COMMUNICATION CONNECTION.....	44
	6.7.1 <i>RS485 Communication</i>	44
	6.7.2 <i>GPRS Communication</i>	47
6.8	DISASSEMBLING.....	47
	6.8.1 <i>Safety Instruction</i>	47
	6.8.2 <i>Mounting and dismounting of cover panel</i>	48
7	COMMISSIONING.....	49
7.1	VERIFY BEFORE COMMISSIONING.....	49
7.2	INVERTER COMMISSIONING.....	49
7.3	MODIFY MOTOR PARAMETERS.....	51
7.4	MOTOR PARAMETERS' DETECTION AND COMMISSIONING.....	52
	7.4.1 <i>Motor parameters' detection</i>	52
	7.4.2 <i>Commission</i>	53
7.5	INVERTER OPERATION MODE SWITCH.....	56
7.6	OVERLOAD CURRENT SETTING.....	56

7.7 STOP FREQUENCY SETTING.....	56
7.8 TIME CALIBRATION.....	57
8 LCD PANEL OPERATING INSTRUCTIONS.....	58
8.1 INVERTER LCD DISPLAY.....	58
8.1.1 LED Indicator Direction.....	58
8.1.2 Description of Buttons.....	59
8.1.3 LCD Display Interface Overview.....	60
8.2 INITIAL OPERATIONAL INTERFACE.....	62
8.3 SYSTEM PARAMETER QUERY AND SETTING.....	63
8.3.1 Query information item description.....	63
8.3.3 Information inquiry.....	77
8.3.4 Parameter Setting.....	79
8.4 Malfunction Description.....	82
9 MALFUNCTION AND TROUBLESHOOTING.....	85
9.1 TROUBLESHOOTING.....	85
9.2 MAINTENANCE.....	92
9.3 CONTACT CUSTOMER SERVICE.....	93
10 APPENDIX A.....	94
11 APPENDIX B.....	97

1 Safety Instructions

For the electrical and electronics equipment, safety relates to the whole process of installation, commissioning, operation and maintenance. Therefore, incorrect use or operation would damage the life and personal security of operating person or the third party, and inverters.

In order to reduce casualties, damage of inverter and other equipments, user or operating person should strictly abide by all the safety information tips of danger, warning and note which are in the process of operating and maintaining.



Warning !

All the installation and operation of Solar pumping inverter must be completed by professional and technical person. Professional and technical person need:

- Receive special training
- Read this manual completely and master the operation related to safety matters. Any damage caused by improper installation or operation which do not according to the introduction in this manual will be beyond the warranty scope of our company.

Before installation



Notice !

User should check the inverter if there is any damage during transportation. Please contact Supplier or transportation company immediately if some problems of inverter are found.

Installing

Ensure inverter not have electrical connections and electricity before installing.



Danger!

The solar cell arrays should be covered with opaque materials when installing the photovoltaic arrays during the day, otherwise the solar cell arrays will generate high voltage, causing person casualties.



Danger!

When the input AC end is connected to the inverter, the ac input side circuit breaker should be disconnected, otherwise the AC input will produce dangerous voltage, causing personal casualties. Do not conduct wiring operations by non-professionals.



Warning!

Good ventilation should be ensured when the inverter is running.
The inverter should be installed vertically, and no shielding should be guaranteed for the heat sink.



Warning!

Inverter damage caused by the following circumstances will not be covered by the company's warranty.

- When photovoltaic array configuration, ensure that the dc side of the maximum short-circuit current in the allowed range of the inverter, otherwise it may cause

non-recoverable damage to the inverter.

- When photovoltaic array configuration, make sure that the open-circuit voltage of each photovoltaic group does not exceed the maximum DC input voltage of the inverter. For the maximum DC input voltage of JNPxL and JNPxH series pv pump inverters, please refer to the technical parameters of each type of inverters in the appendix.



Warning!

Improper installation environment of inverter will affect machine performance and may cause machine damage.

Do not install the inverter in flammable, explosive or flammable, explosive storage places.

Do not install the inverter in an area where it may be struck by lightning.

Do not install inverters in places with more salt fog.

Electrical connection



Danger!

When installing photovoltaic arrays during the day, apply light-tight materials to cover the solar array. Otherwise, the solar array will generate high voltage and cause human casualties when exposed to sunlight.



Warning!

Do not close any circuit breaker until all equipment is fully connected.

**Notice !**

All electrical installations must comply with local and national electrical installation standards.

**Notice !**

To ensure safe operation, correct grounding, proper conductor size, and necessary protection against short circuits are required.

**Notice !**

The connecting cable must be of proper specification, firmly connected and well insulated.

In the operation of the**Danger !**

When the inverter is loaded on the AC side, it is not allowed to disconnect the DC connection directly. First, make sure that the inverter is shut down and there is no output in the AC output, and make sure that there is no voltage between the AC input side and the DC input side, then disconnect the connection between the AC and DC input side.



Danger!

Do not plug or unplug any connector when the inverter is in live state.

Do not open the cover of the machine when the inverter is live!



Notice!

During the operation of the inverter, only the LCD display screen can be touched, and the heating elements of the machine (such as the radiator) cannot be touched to prevent burns.

Maintain



Danger!

Maintenance work should be carried out by professional maintenance technicians. Before inspection or maintenance, be sure to disconnect the electrical connection on the input side of the machine. After waiting for at least 10 minutes, measure the voltage on the DC side and ac side of the inverter with a voltage meter to ensure that the operation is carried out without voltage on both the DC side and AC side.

2 product presentation

2.1 Introduction to pv pump inverter

Photovoltaic pump system is different from the traditional ac pump application system, the photovoltaic pump system is the use of solar cells convert solar energy into electrical energy directly, and then driven by photovoltaic pump inverter ac motor drives the pump, such as jiang river lake from a deep well water source water, and then transported to the destination, to meet the needs of the (user) on the water of the system is mainly composed of four parts: the photovoltaic array photovoltaic pump inverter single-phase or three-phase ac pumps, as well as the pipeline and photovoltaic array absorbs sunlight radiation energy storage device, is transformed into electrical energy, for the whole power system power supply

Photovoltaic pump inverter as an important part of photovoltaic pump system, it will be a photovoltaic array output direct current into alternating current (ac) drive pumps, according to the changes of the intensity of sunlight in real time to adjust the output voltage and frequency, to achieve maximum power point tracking, maximize the use of solar energy JNPxH series inverter on the basis of traditional photovoltaic pump inverter, strengthen the function of ac input complement, in the case of photovoltaic energy shortage, ac input energy can according to demand to supplement, in order to ensure the normal supply of users in the night or cloudy days



Warning !

The inverter cannot be connected to a photovoltaic group with a positive or negative grounding.

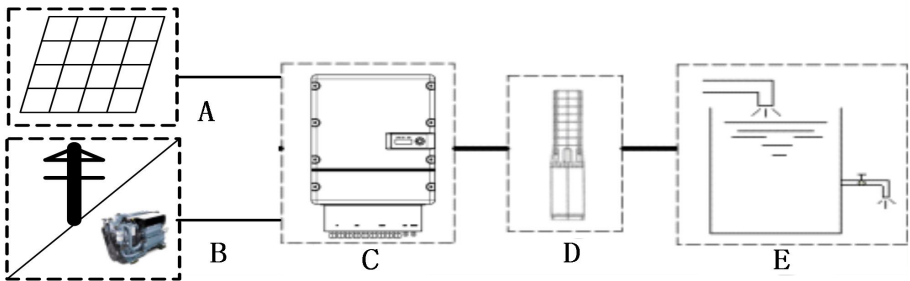

Figure 2-1 Photovoltaic pump inverter application system

Table 2-1 Application system list of pv pump inverter

No.	Name	Description
A	PV array	Monocrystalline silicon, Polycrystalline silicon.
B	Grid/Diesel generator	Single phase or three phase AC source.(see the appendix of each model for specific requirements)
C	Solar pump inverter	JNP22KH、JNP30KH、JNP37KH、JNP45KH、JNP55KH
D	AC pump	Three-phase AC pump
E	Water storage device	Can be the reservoir, fields etc.



Explain!

Photovoltaic pump system configuration need to ensure that the maximum power point of pv array voltage V_{mp} with ac rectifier voltage $V_{mp} 1.414 * U$

line basic equal or close to it, and input the JNPxL series grid voltage of single phase inverter input U is the single-phase ac line voltage, input the JNPxH series grid voltage of three-phase inverter U line voltage between any two lines, for example, to 30 Vmp JNPxH series single block panels, 18 series, $V_{mp} 18 = 30 * 1.414 * 380 = 540 \text{ V}$ to 537.3 V If the PHOTOVOLTAIC array configuration is not appropriate, when the photovoltaic energy and AC energy are simultaneously connected, the photovoltaic energy utilization rate may be poor

2.2 Product Introduction

2.2.1 Product appearance

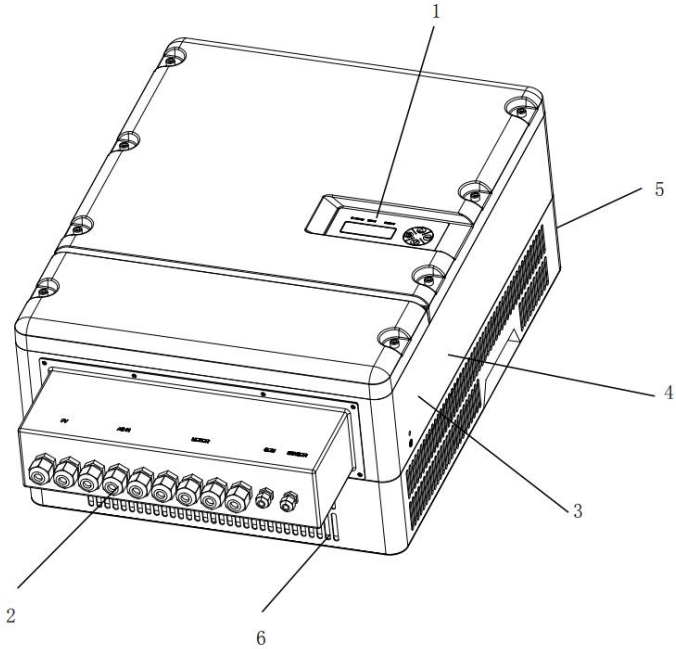

Figure 2-2 Photovoltaic pump inverter appearance diagram

Table 2-2 Inverter appearance information table

No.	Name	Introductions
1	LCD display screen	Man-machine interface, you can check the inverter operating information through LCD display screen, also can set some function and parameters of inverter.
2	Terminals Cover	Including DC input terminal (PV+、PV-);AC input

		terminal(AC IN); output terminal (MOTOR); sensor connection terminal (SERSOR) and communication terminal(COM) under the cover.
3	Machine serial No.	The serial number of the inverter, should be provided during after-sales service
4	Nameplate	The basic parameters of the inverter are listed on the name plate
5	Hanger	Used to hang the inverter on the bracket.
6	Radiator	Help the machine to dissipate heat. The temperature of the inverter is high during operation. DO NOT touch it!

2.2.2 Production Dimensions

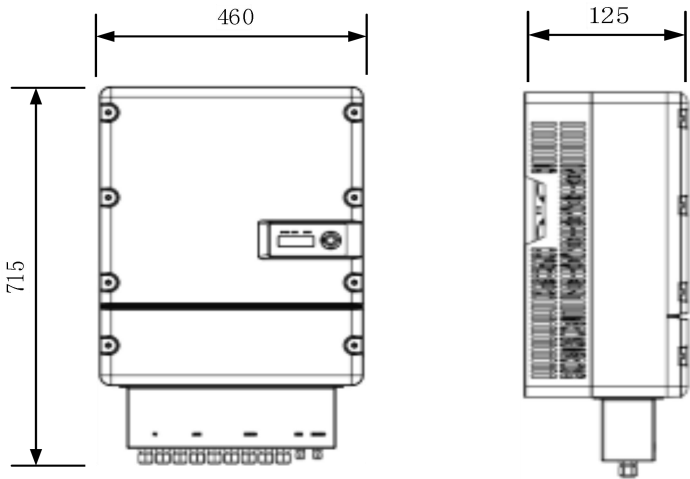

Figure2-3 Dimension drawing of Solar Pump Inverter (unit : mm)

Table2-3 Inverter dimension table

Model	Width(mm)	Height(mm)	Depth(mm)	Net weight (kg)
JNP22KH-V5	460	715	125	44
JNP30KH-V5	460	715	125	44
JNP37KH-V5	460	715	125	44
JNP45KH-V5	460	715	125	44
JNP55KH-V5	460	715	125	44

2.2.3 Product Name

The Naming of product, take JNP3K7H-V5 for example:

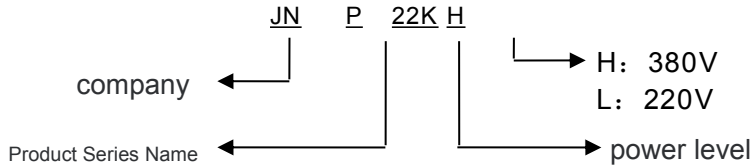

3 Inverter Unpacking

3.1 Unpacking Check

The product has been tested and checked carefully before transportation, but damage may be caused during transportation, therefore, the product should also be checked carefully before installation.

- Please check whether inverter outer packing is in good condition;
- After unpacking, please check whether the equipment is in good condition;
- According to the packing list to check whether all the parts is correct and in good condition.

If any damage is found, please contact supplier or the transportation company. Please keep well the photos taken at the damaged parts and we'll provide you with best and fastest services.

Supplier supply the standard inverter and commonly used accessories as below:



Figure3-1 Inverter and standard fittings



Note !

Photos are for reference only, please adhere to the original product!

Table3-1 Inverter and fittings table

No.	Description	Status
1	Solar Pump Inverter	Standard
2	Fixing rail	Standard
3	Water level sensor B	Optiona
4	Cold pressing terminal (SC4-5)	Standard
5	expansion bolt	Standard
6	certificate of inspection	Standard
7	specification	Standard
8	container loading list	Standard
9	Water level sensor A	Optional
10	pressure sensor	Optiona
11	Signal terminal row	Standard
12	Cold pressing terminal (SC35-8)	Standard

3.2 Identify Inverter

The nameplate in the side of inverter, and it shows the inverter model, main parameters and certificate mark.

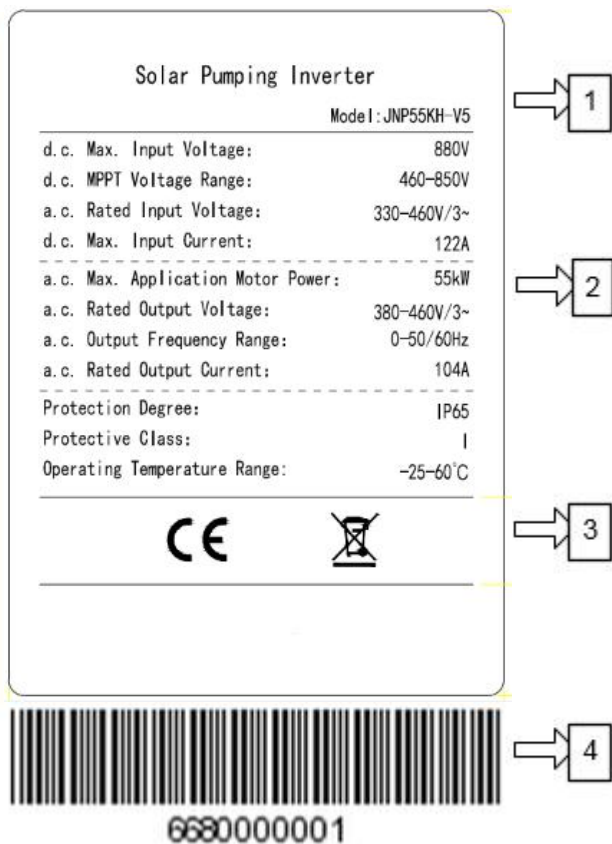

Figure3-2 Inverter nameplate

NO.	Description
1	Inverter name and model
2	Inverter parameter information
3	Certificate and safety signs, concrete meaning as “Preface”





4	Inverter factory number
---	-------------------------

4 Installation Procedure

4.1 Prepare Installation Tools

The following tools will be needed during inverter installation and wire connection. You also can choose the right tools according to your own experience.

Table4-1 Installation tools list

Sketch map	Name	Recommend specification	Function
	hydraulic tong	10~70mm ²	For crimping of cold terminals.
	Electric drill	Φ9	Used for inverter installation plate fixed hole drilling.
	Straight screwdriver	Φ3	For the installation of communication connecting wires.
	Cross screwdriver	Φ5	Used for disassembling inverter cover.
	Inner hexagon spanner	5#	Used for disassembly and assembly of inverter cover panel.

4.2 Installation Steps

Tools ready, follow these steps to install.

Table4-2 Installation process

Installation steps	Installation instruction	Reference chapters
1	Before installation, check whether the inverter is in good condition;	
	Whether the product fittings are complete	3.1
	Whether the installation tools and spare parts are complete	4.1
	Whether the installation environment meets the requirements	1
2	Read the manual, especially the "Safety Instructions"	1
3	Choose the best installation location	5.1
	Installation	5.3
4	Electrical connection	6
	Select cables	6.3
	AC side wire connection	6.4
	DC side wire connection	6.5
	Sensor wire connection	6.6
485 communication wire connection	6.7	
5	Commissioning	7
6	Configuration parameter	8
7	Faults	9

5 Installation

5.1 Installation Site Required

Inverter installation site environment has very important influence to the safe operation, the performance and life of the inverter. Choose the right installation site before install the inverter.

- All installation must comply with local standards.
- Do not install the inverter at a flammable or explosive place or a place where the flammable or explosive materials are stored.
- Do not install the inverter in a place where there is a risk of explosion.
- Do not install the inverter in places where the inverter is vulnerable to lightning strike.
- Do not install the inverter in a higher salt spray environment.
- Inverter installation site must be in good ventilation, do not install the inverter in the closed case, otherwise the inverter will not work properly.
- Inverter protection level is IP65, can be installed outdoor, when the inverter is installed outdoor, should be installed as far as possible in the eaves or other have the shadow place, avoiding direct sunlight, rain and snow.
- Inverter is installed indoor, keep away from windows, avoiding lightning
- The installation place selected should be solid enough to support the inverter weight for a long period.
- The site for inverter installation must be clean and the ambient temperature must be maintained within -25 to +60 °C.
- Inverter installation site relative humidity should not be more than 95%, water vapor may corrode inverter, and damage the internal components.
- The inverter must be installed in a place convenient for observation and

maintenance.

- Don't install the inverter in living area, the inverter will produce some noise when running, influence daily life.

5.2 Installation Direction

- The inverter should be installed vertically or tilted backwards with a maximum angle of 10°.
- Do not install inverter tilted forwards.
- Never install the inverter horizontally.

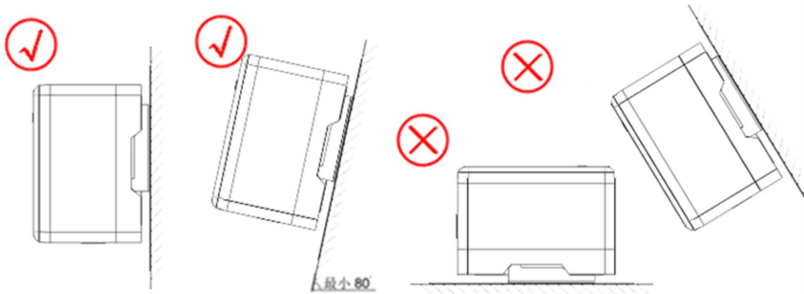

Figure5-1 Installation directions

- The installation height of inverter should be convenient for operation and reading out of the LCD displayed information.
- Do not install the inverter in a place where children can touch.
- The inverter uses air cooling mode and the installation site selected should ensure the minimum installation spacing between the inverter and the fixed object and the nearby inverters to ensure an good ventilation. And in front of the inverter need to keep enough space, is convenient to check the LCD display information.

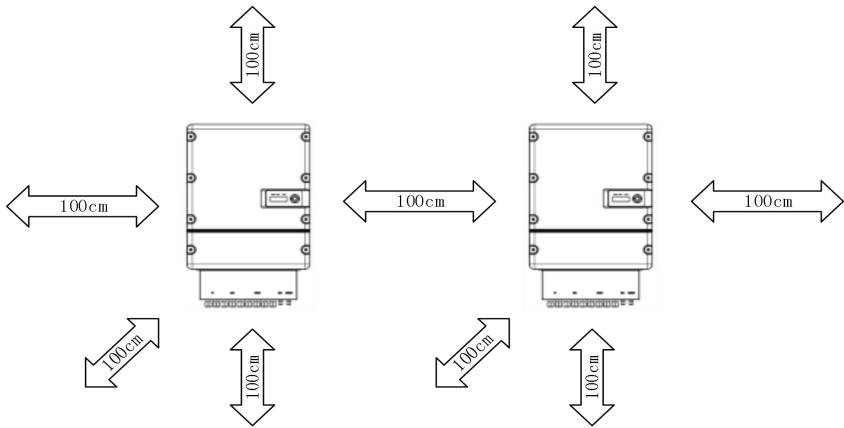

Figure5-2 Minimum spacing of adjacent installations

Table5-1 Minimum spacing dimension

Direction	Minimum spacing
Above	100cm
Below	100cm
Sides	100cm
Front	100cm

5.3 Installation of Inverter



Note !

Do not use jackbolts or screws to install inverters on rocks or panels.



Note!

- Fix the inverter on the rock or panel with the toggle bolt or screw is not permitted.
- Supplier would provide the bolt which suitable for the installation on the concrete wall.
- If the inverter is fixed on the wooden wall, please choose suitable bolt to finish the installation, the bolt length should be enough and penetrate the 1/2 depth of the walls.

Step 1: Select an appropriate hole on the wall according to the size of the inverter. It is recommended to drill holes with a diameter of $8+1/-0$ mm, a depth of $60+5/-0$ mm, a spacing between left and right holes of 180mm, and a spacing between upper and lower holes of 170mm, and then drive the expansion bolt into the hole

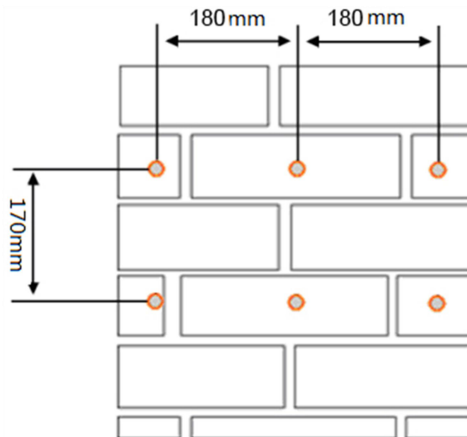

Figure 5-3 Bitmap of the JNPxH mounting hole

Step 2: Use expansion bolts to fix the mounting sheet metal to the wall. Lock the expansion bolt until the expansion bolt is attached to the wall.

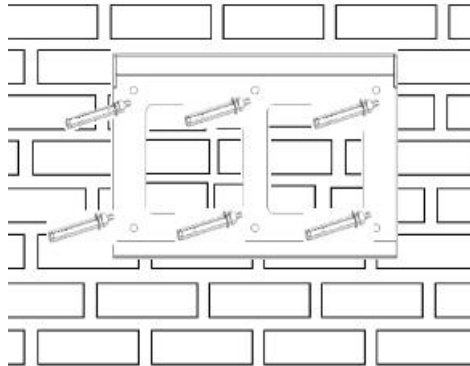

Figure 5-4 Installation of expansion bolts

Step 3: Hang the mounting lug on the back of the inverter onto the mounting sheet metal until the inverter is firmly installed on the panel, then release the inverter.11 Appendix B

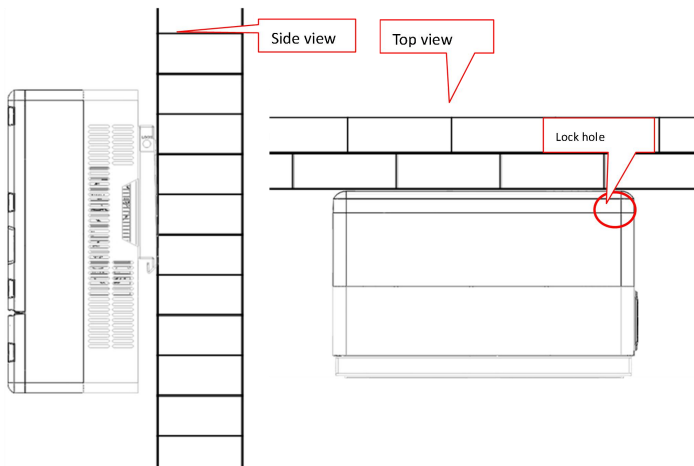

Figure 5-5 Completion effect of installation

6 Electrical Connection

The electrical connection can be carried out when the mechanical installation of inverter is completed. The following operation specification must be followed when making electrical connection.



Warning!

- All the electrical connection must meet local electrical connection standard.
- Only qualified electrical personnel can perform the wiring installation work.
- Incorrect wiring operation may cause operating casualties or equipment damage permanently.
- Ensure that there is no electricity in DC side before the electrical connection.
- Grounding correctly, using proper conductor and taking necessary Short-circuit protection to ensure the safe operation of inverter.
- Don't switch on any breaker before all the electrical connection are finished.

6.1 Connecting Terminals of Inverter

All the connecting terminals are at the bottom of the inverter, and the terminal cover is disassembled with a phillips screwdriver. There are DC side input (PV) terminals, AC side input (AC IN) output (MOTOR) terminals, communication terminals and water level sensor terminals inside. As shown in the figure below.

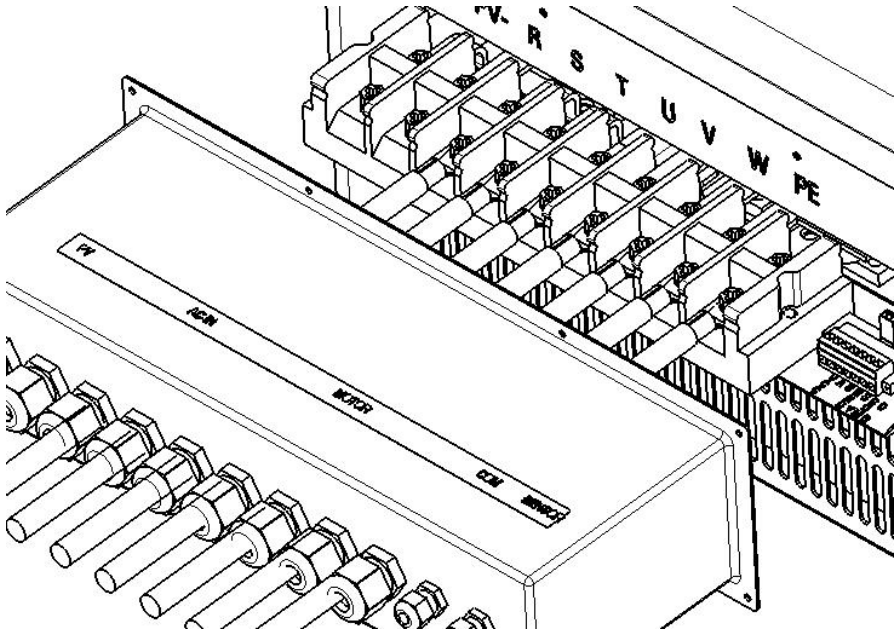



FIG. 6-1 External connection terminals of the inverter

Table6-1 Description

Terminals	Description
AC IN	AC input terminals, including R,S,T,PE.
PV	PV array DC input terminals, including PV+,PV-.
MOTOR	Output terminal, connect with AC pump, including U,V,W.
SENSOR	Water level sensor signal input terminal (optional)

COM	RS485 or GPRS communication interface (optional)
	Grounding terminal(Grounding screw on the right side of inverter case)

6.2 Schematic Diagram of Electrical Connection

Figure 6-2 is the schematic diagram of electrical connection among PV arrays, Solar Pump Inverter and three phase AC pump. Water level sensor and communication interface shall be connected if needed.

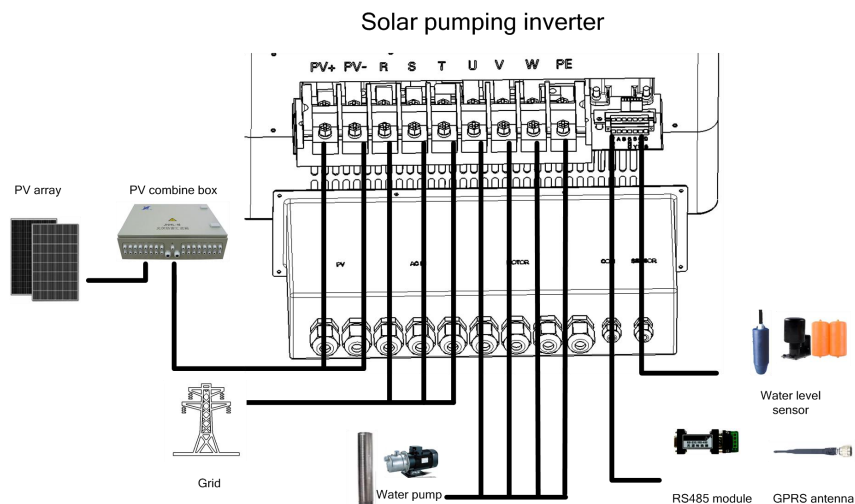

Figure 6-2 schematic diagram of electrical connection of photovoltaic pump inverter

Table6-2 Equipment list of Solar pump system

No.	Equipment name	Description
A	PV array	The max. Voc of each string is 880V.
B	Grid	Power grid, diesel generator or other AC input

		sources.
C	Pump	Single phase or three phase AC pump.
D	RS485 Communication module	Optional, can be purchased from Supplier
E	Water level sensor	Optional, for Dry or Overflow protection.
F	GPRS module	Optional, Use for GPRS communication.

6.3 Cable Selection

Please select cable according to the following table.

Table 6-3 Specification of Cables for Electrical Connection

Inverter	Cable range (AWG)			Cable recommended (AWG)		
	DC side	AC side		DC side	AC side	
	PV+, PV-	U, V, W	PE	PV+, PV-	U, V, W	PE
JNP55KH-V5	1/0	1	5	1/0	1	5
JNP45KH-V5	1	3	5	1	3	5
JNP37KH-V5	3	3	5	3	3	5
JNP30KH-V5	4	4	5	4	4	5
JNP22KH-V5	5	5	5	5	5	5

6.4 AC Side Electrical Connection



Notice !

It's forbidden to connect several inverters in parallel to one set of pump!



Danger!

Ensure that all cables have no charge before electrical operation!

Step1: Connect the wires first:

Follow the steps below to connect the AC wires:

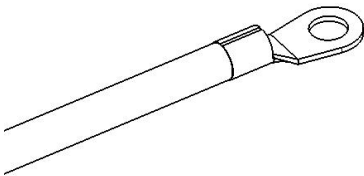
Operation Instruction	Operation Demonstration
<p>Step1. Fasten the three-phase input, three-phase output and grounding wires to the cold pressing terminal (SC35-8) with crimping pliers seperately.</p>	

Step2: Fix the AC wire (R, S, T, PE, U, V, W) on the terminal through the corresponding waterproof terminal on the terminal cover. Note: R, S, T, PE pass through the AC in waterproof terminal, U, V, W pass through the motor waterproof terminal. R,S,T are AC input terminals, and U,V,W are AC output terminals which should be connected to pump.

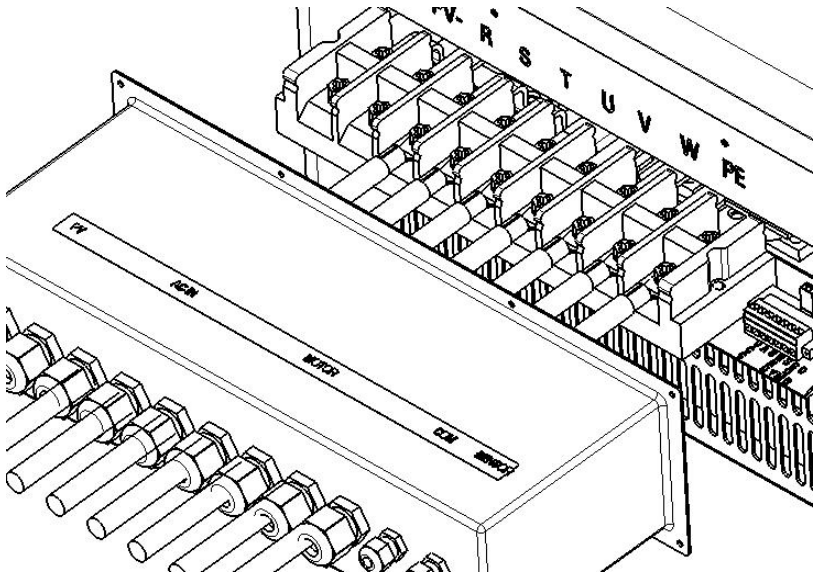

Figure6-3 AC side electrical connection



Note!

The phase sequence between AC pump and inverter must be same, otherwise, it shall lead to less output or without water. Whether Phase sequence is corresponding or not should be tested when the pump system trial run for the first time.

For single phase pump, there is no sequence required after start capacitors are moved out.



Danger!

When the input AC terminal is connected with the inverter, the circuit breaker at the AC input side shall be disconnected, otherwise the AC input will generate dangerous voltage, causing personal injury and death. Do not operate wiring by non professionals.

Please make sure the AC input and AC output wiring is correct, Do not connect the input and output reversely, otherwise the inverter will be damaged.

Please make sure that three phase AC input the R, S, T and grounding are correctly connected to the Corresponding terminals. Do not connect the AC input R, S, T to the grounding terminal wrongly. Otherwise, it will damage inverter.

Make sure single AC input Live line , neutral line and grounded line are connected to corresponding R,S and PE terminals, T keeps without any connection, Do not connect R, S and AC input grounding wrongly.



Notice!

Different types of inverters have clear requirements on AC power supply voltage, frequency and power supply mode, etc. For specific requirements, please refer to the corresponding technical parameters table of each type of inverters in the appendix. It is strictly prohibited to connect power supply

sources that do not meet the requirements to the inverter, otherwise the following consequences may occur:

- The inverter is not recoverable damage.
- The operation of the machine is unstable, manifested as unstable pipeline water flow, pump running noise, etc.

6.5 DC Side Connection



Danger!

When carrying out connection between PV array and inverter, the PV array should be covered with opaque materials and the DC-SWITCH should be disconnected, otherwise, the PV array may generate dangerous voltage, cause casualty. The Non-professionals do not make the connection operation.



Warning!

Before connecting PV array to the inverter, ensure the earth impedance between PV array and ground is not less than 1Mohm.



Note!

- If there is more strings PV modules in parallel, each string PV module should be with the same model, the same number of PV modules, the same inclination angle, the same azimuth angle, and the same cross-sectional area of the connecting wires.
- Inspect every system carefully before installation.

Step1: Please connect the wire of DC according to the following steps:

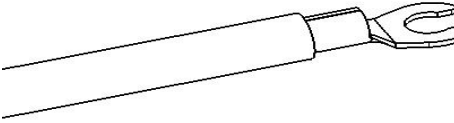
Operation Instruction	Operation Demonstration
1. Connect DC wire and cold terminal (SC35-8) firmly by crimping plier.	

Step2: Through the PV waterproof terminal on the terminal cover, fix the DC wire (PV +, PV -) on the terminal, pay attention to the positive and negative poles shouldn't be connected reversely, and ensure that the circuit breaker at the DC side of the system is in the off state.

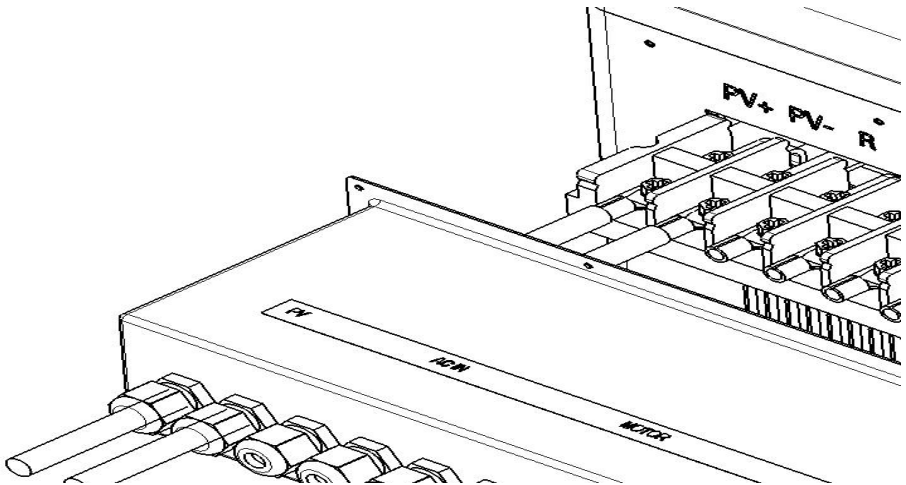

Figure6-4 PV side electrical connection



Warning!

Make sure the Positive and Negative poles connection of PV array and Inverter are correct!

6.6 Water Level Sensor Connection

Dry protection function: There are two kinds of detection models, automatic and manual. Automatic dry protection is achieved through inverter's software. And manual model need water level sensors to input signal through SENSOR inside Inverter.

Overflow Protection: water level sensors are requested to input signal through SENSOR inside Inverter.



Note!

- The water level sensors' location is designed according to your system situation.
- Water level sensor can be bound in corresponding position on the pipeline connected to the pump. Other method also can be used to ensure the water level sensor is in the right position.
- The installation of water level sensor must be reliable and effective.
- When use water level sensor to achieve function of overflow protection, set "OFF" as "ON", please refer to "**8.3.4.3 Key Parameters of the System Set**" for detail information.

6.6.1 Water level sensor interface define

Water level sensor connector pins in inverter panel port are defined as below:

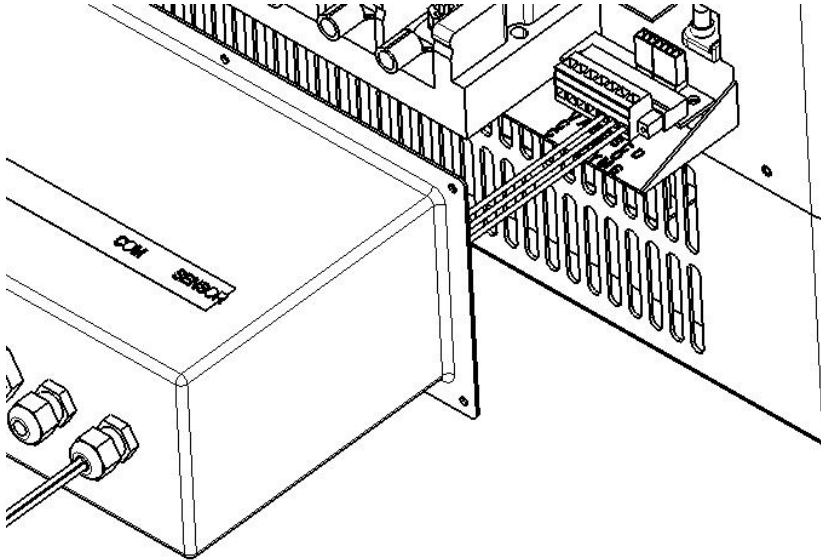

Figure6-5 Water level sensor interface define

Table 6-4

Terminal (SENSOR) pin	Detail
DG	Dry protection pin
SY	Overflow protection pin
COM	Dry protection and Overflow protection common pin,

Table 6-4

Terminal (SENSOR) pin	Detail
DG	Dry protection pin

SY	Overflow protection pin
COM	Dry protection and Overflow protection common pin,

6.6.2 Water level sensor connection

Two kinds of water level sensor you can select as shown below:

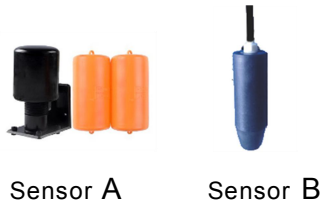

Figure6-6 Water level sensor



Notice !

If you select overflow protection water level sensor, you need to set the value of "OF-F", the LCD menu "Settings" → "Para Set" → "OF-F" to modify to "ON". The setting method with reference to "**8.3.4.3 Key Parameters of the System Set**".

If you selected water level sensor A, then water sensor installation method is shown below:

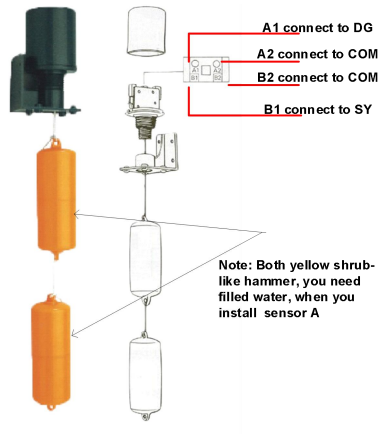

Figure6-7 The detail figure of Sensor A

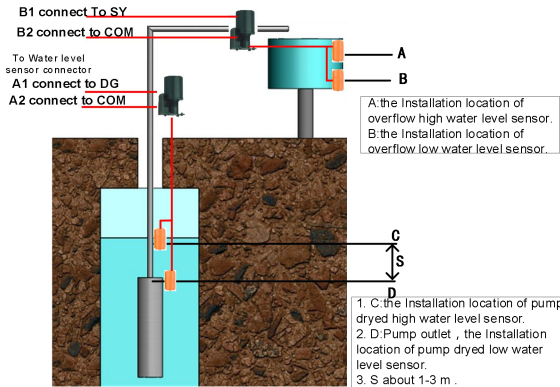

Figure6-8 The installation figure of Sensor A

If you selected water level sensor B, then water sensor installation method is shown below:

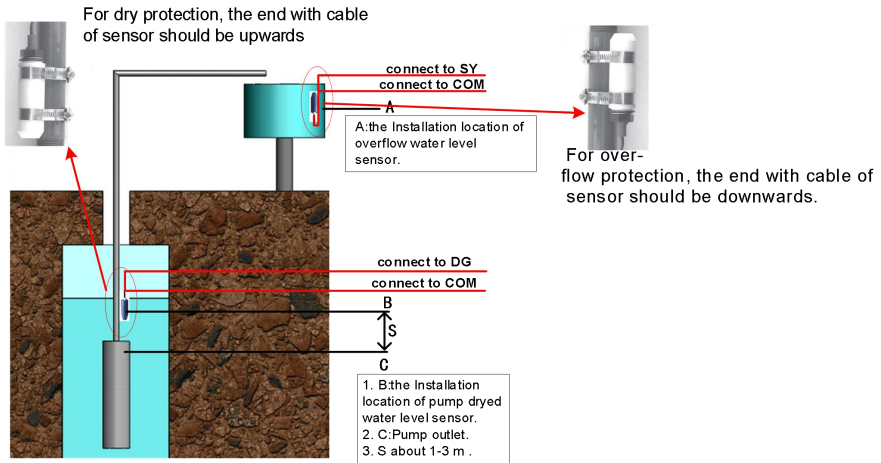

Figure6-9 The installation figure of Sensor B

6.7 Communication Connection

6.7.1 RS485 Communication

When the inverter communicates with a single machine, the communication between the inverter and the monitoring equipment can be connected through the communication cable. The COM outside the inverter is the remote communication terminal, and the output terminal wire is connected to the monitoring equipment (computer).

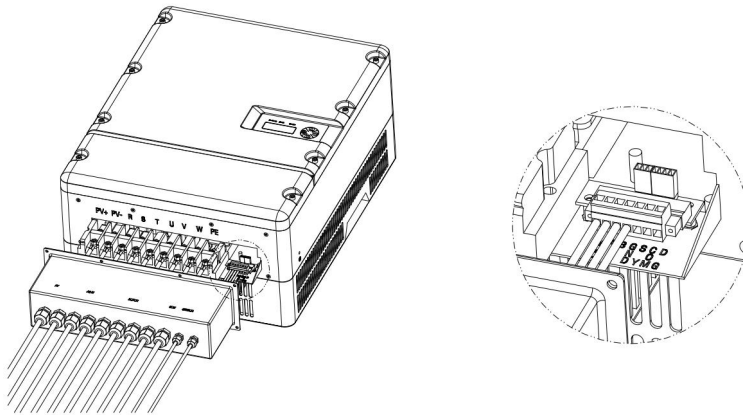

Figure6-10 Communication connection terminal

The com part of the machine panel and the water level sensor use the same terminal block, and the pin definitions are shown in the table below:

Table 6-5 COM terminal pin definition on machine panel

Terminal (SENSOR) pin	Detail
VCC	+5V power supply
A	RS485 communication port A.
B	RS485 communication port B.
GND	Electrical grounding

The following diagram guide you to connect a single inverter to monitoring equipment.

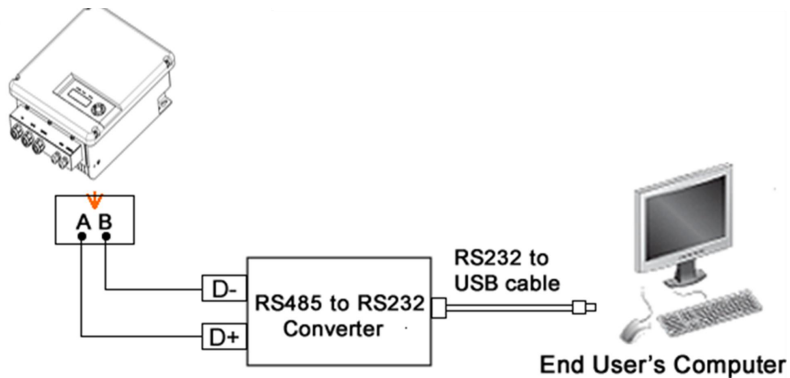

Figure6-11 Diagram of single communication wiring

The wiring diagram is schematic diagram, just take HEXIN converting module as an example. If the user choose other converter, need according to the converter's instructions, wiring the inverter's A, B wires to the converter's correct terminal.

Please refer to **"Inverter Management System User Manual"** for the corresponding monitoring software settings, after completing the wire connection.



Note !

- The monitoring software is optional, when choose this function, “**Inverter Management System User Manual**” can be found from the accompanying CD.
- The inverter is supplied with default address "10".

6.7.2 GPRS Communication

Note: More information about the communication module, please refer to the **User and Installation Manual For GPRS**.

6.8 Disassembling

6.8.1 Safety Instruction



Warning !

Before disassembling the inverter:

- Turn off the DC switch.
- Waiting for a few minutes till ensure the inverter is uncharged.



Notice !

Electrostatic discharging will cause damage to the inner components of inverter. We should carry out the antistatic measure before disassembling and assembling.

6.8.2 Mounting and dismounting of cover panel

For maintenance reason, you may need open the cover of inverter, and ensure better seal performance, please operate according to the following instruction.

1. When open the inverter cover, first use a cross screwdriver to remove the grounding screw on the right side of the inverter case, and then use a 5# Allen wrench to screw down the cover plate fixing screws in turn, and install the gasket under the screw. When screwing down, pay attention to prevent the gasket from falling off.
2. when cover it back, first use a cross screwdriver to lock the grounding screw on the right side of the inverter case, then screw all the cover screws into the screw holes, use a 5 × Allen wrench, with a torque of $1.8 \pm 0.2\text{N} \cdot \text{m}$, first lock the diagonal screws, and then lock the other screws in turn.

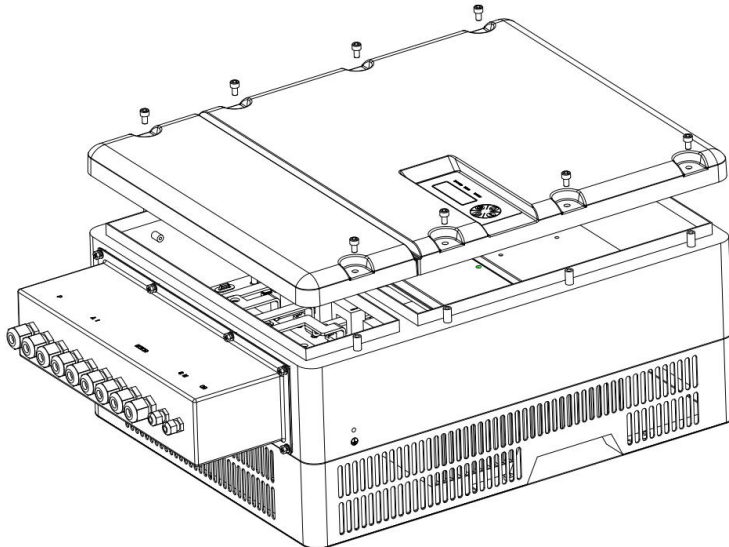

Figure6-12 Reference picture of Mounting and dismounting

7 Commissioning

7.1 Verify before Commissioning

PV Arrays

The PV array should be checked before operating the inverter, and to ensure that the positive and negative mustn't be misconnect, otherwise, the damage may be caused to the inverter. Make sure that the open-circuit voltage of PV array doesn't exceed the required voltage.

DC Input

Make sure that the DC terminals of the inverter are connected correctly and maintained consistent with the PV array.

AC Input/Output

Make sure R, S, and T of the AC input terminal of the inverter are properly connected. Do not connect R, S, and T to the ground pin. Make sure that the AC-side of inverter is connected correctly, and phases of AC-side are connected correctly.

Verify of the water pump motor parameters

Check the electrical parameters on water pump motor nameplate: the rated input voltage and input current frequency, to ensure inverter is matched with the pump.

7.2 Inverter Commissioning

Choose suitable weather, with enough sunshine, and make sure the normal operation of your Solar pump system. Try to ensure that inverter work under high output power, high output frequency as much as possible. Please make sure the following condition before commissioning.

- Ensure that the inverter is connected correctly to the AC motor.

- Ensure that the polarity of PV arrays is correct.
- Ensure that the AC Input R、S、T and GND is correct.
- Check whether the system pipeline is unobstructed or not.
- Switch on the DC-side circuit breakers.

After finishing the above steps, then begin initialization.

According to the pump motor rated current value on the nameplate, setting inverter overload protection value, the method is: modify the “Imotor” value equal to 1.2 times of the motor rated current, the details please refer to chapter **"8.3.2.3 DSP Parameter Settings" "8.3.4 parameters"** settings.

After finishing the above steps, machine shall start operation after long-time pressing the “ON/OFF” key for 3s; check if the Solar pump system works properly or realize suitable head of delivery and flow. Press “ON/OFF” and stop the inverter. Disconnect the DC side input of the PV array, connect the AC input side power supply, and repeat the above operations.



Note!

The inverter mainly has 5 working modes, the factory default is 6 (continuous motor parameter detection mode): when the debugging mode is 0, it means that the inverter is in vector mode + reliable mode. Under this mode, it is vector control mode and reliable operation mode.

When the debugging mode is 1, it means that the inverter is in VF mode + reliable mode. Under this mode, it is VF control mode and reliable operation mode.

In the operation of these two modes, when the system is jointly powered by photovoltaic and power grid, in order to ensure full load operation of the system, the inverter will draw electricity from both the power grid and photovoltaic at the same time to ensure stability of the system.

When the debugging mode is 2, the inverter is in vector mode + economic mode, which is vector control mode and economic operation mode.

When the debugging mode is 3, the inverter is in VF mode + economic mode. In this mode, it is VF control mode and economic operation mode.

When operating in these two modes, when the system is jointly powered by photovoltaic and power grid, the inverter gives priority to photovoltaic energy, when photovoltaic output frequency & LT;

When the power grid access frequency (which can be set), the inverter takes the initiative to connect the power grid to meet the operating requirements of the system;

With the increase of pv power, when PV power & GT;

When the power grid exits (configurable), the inverter will take the initiative to exit the power grid

7.3 Modify motor parameters

After initialization, enter into critical parameters' setting, check inverter default with pump motor parameters, including : “U-Rated”, “I-Rated”, “P-Rated”, “F-Rated”, “RPM-Rated”, “PF-Rated”, and modify the inconsistent default of inverter.

Please refer to “**8.3.2.2 DSP parameter setting**” for system critical parameters' setting.

The default motor parameters are shown as the below table 7-1.

table 7-1: The default motor parameters

Model	Rated volt.	Rated current	Power	Frequency	Rated rotate speed		Power factor
					Surface pump	Submersible pump	
JNP22KH	380V	42A	22KW	50Hz	1475	2875	0.86
	---	---		60Hz	1770	3450	

JNP30KH	380V	57A	30KW	50Hz	1475	2875	0.86
	---	---		60Hz	1770	3450	
JNP37KH	380V	71A	37KW	50Hz	1475	2875	0.86
	---	---		60Hz	1770	3450	
JNP45KH	380V	85A	45KW	50Hz	1475	2875	0.86
	---	---		60Hz	1770	3450	
JNP55KH	380V	104A	55KW	50Hz	1475	2875	0.86
	---	---		60Hz	1770	3450	

7.4 Motor parameters' detection and commissioning

7.4.1 Motor parameters' detection

7.4.1.1 Motor parameters' detection

After modifying the motor parameters, press "ENTER" and "DOWN" at the same time to return to the main interface of the priority screen, and then long press "ON/OFF" key 4S, the inverter starts to test the motor parameters. If the test is completed correctly, it will prompt "Test is completed, whether to start up"; If the detection fails, the inverter will prompt "stator detection fails". In this case, it is necessary to refer to "Fault 200~ Fault 203" in "9.1 Troubleshooting" to find the cause.

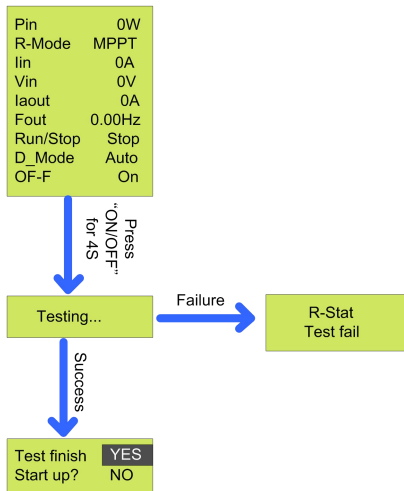

Figure 7-1 Motor Parameters' Detection Interface



Note !

In some special occasion, re-detection of motor parameters is required, such as change pump, the “DebugMode” should be changed to 6, then press “DOWN” and “ENTER” at the same time to return to the first screen, and begin detect.

7.4.2 Commission

7.4.2.1 Self-detect motor parameter

After finishing motor parameters' detection, LCD screen will indicate” Test finish start up? YES/NO”, select “YES”, and inverter will start; select “NO”, inverter will stay in motor detection model, and re-detect when start it again.

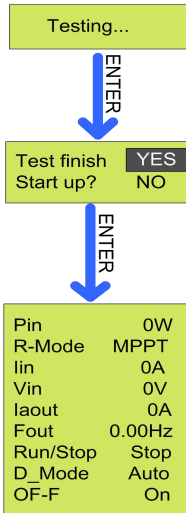

Figure 7-2 Inverter start to operation inverter



Note !

- If there is no water output , or flow rate is less than normal situation, even there has abnormal sound of pump, possible reasons are shown below:
 - a) Pump motor reversal caused by wrong phase sequence connection. Stop inverter, enter into “M-Mode” setting interface, please refer to “**8.3.2.2 DSP parameter setting**”;
 - b) Output power of PV array is not enough.
- If there occurs abnormal during the first commission, please refer to “**9.1 Troubleshooting**” for trouble shooting.
- If it occurs output frequency is very low, and output current is very big at the same time, please refer to “**7.4.2.2 Motor parameters’ setting by manual**”.

7.4.2.2 Motor parameters' setting by manual

If inverter alarm malfunction and cannot pump water caused by mismatching parameters during the first commissioning, setting motor parameters by manual is required.

First step: Stop inverter;

Second step: refer to “**8.3.2.2 DSP parameter setting**” to change “MP-Sel” to “manual”;

Third step: Press “ENTER” and “DOWN” at the same time to return to the first screen.



Note !

- a) This four parameters of “R-Stat”, “R-Rotr”, “L-Mutu”, “L-Leak” in the setting menu are default;
- b) If start the inverter based on those default, but it occurs output current exceed motor rated current by 4%, and output power is less than 50%, and the output frequency is normal, that means “R-Stat” is bigger. Solution: Stop inverter, enter into setting menu to reduce “R-Stat” by 10%, and try again. If it still cannot work, reduce by 10% every time till system can run well (40% max.).
- c) If it occurs output current is big, but output frequency is low, and no water output, which may caused by the mismatching of “R-Stat” and “L-Mutu”. Solution: Stop inverter, enter into setting menu to reduce “R-Stat” and “L-Mutu” by 10% respectively, and try again. If it still cannot work, reduce both by 10% every time till system pump water (40% max.). If it occurs situation b) at this time, please refer to b) solution to solve it.
- d) If it occurs abnormal during the first commissioning, please refer to “**9.1 Troubleshooting**” for reason.

7.5 Inverter Operation Mode Switch

There are two kinds of operation mode of Inverter, one is Vector Control as default, and the other one is VF Control. If you want to try VF, or the performance of Vector is not good, please refer to the following step:

First: Stop inverter, and ensure it's standby;

Second: Refer to **"8.3.2.2 DSP parameter setting"** to set the "DebugMode" as "3";

Third: Refer to **"8.3.2.2 DSP parameter setting"** to set the "Run-Mode" as "CVT";

Forth: Set the "UINST" as $0.85 \times V_{in}$ (standby);

Fifth: Return to main interface, long-press "ON/OFF" for 4S to start inverter.

7.6 Overload current setting

After the success of first commissioning, please refer to **"8.3.2.2 DSP parameter setting"** to set the "Imotor" as 1.1 times of "I-Rated".

7.7 Stop Frequency Setting

Solar pumping system for the first time trial run is successful, need to set the system shutdown frequency, as follows.

Step 1: Ensure the system is running and there has water output. To enter "StopFreq" interface. Please refer to **"8.3.2.2 DSP parameter setting"**.

Step 2: To reduce the value of "StopFreq". Reduce 5 each time (every change need to press "ENTER" to confirm). Keep reducing till there just has no water output, and make a small change to just get small water come out, and the value is the very data of "StopFreq".

Step 3: Escape the "StopFreq" interface.

Finish the debugging.



Note!

The set of "StopFreq" can ensure inverter stop working when the output power

of PV array is too weak to pump water, which can increase the pump's lifespan.

7.8 Time Calibration

The initial time in the inverter is based on Beijing time zone. Please reset time if it doesn't match local time so that the inverter can record daily, total generating capacity and historical faults information.

Please refer to“**8.3.2.9 Display time setting**”.

So far, Solar Pumping System commissioning finish!

8 LCD Panel Operating Instructions

8.1 Inverter LCD Display

There are three LED lights, four buttons on the LCD Display, shown in figure 8-1.

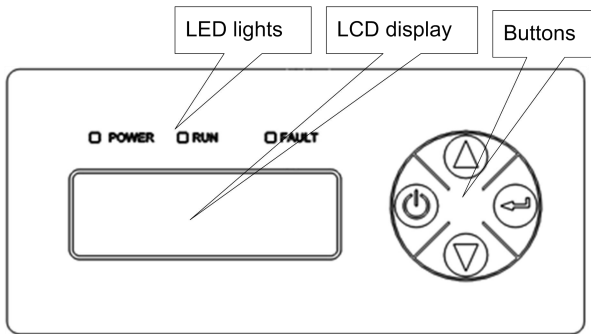

Figure8-1 LCD Display

8.1.1 LED Indicator Direction

Table8-1 LED Indicator Direction

LED Indicator	Name	Color	Instructions
POWER	Power light	Green	Light on When power on
RUN	Running light	Green	Light on under normal operation
FAULT	Faulty light	Red	Light on when error occur, off when fault disappear

Detail Explanation of Indicator





- When inverter is powered on, “POWER” indicator (green) will be lighted.
- Communication fault occurs, “FAULT” indicator flashes rapidly.
- Other outage or shutdown mode occurs, “FAULT” indicator will be lighted,

until fault or status are cleared.

- When invert is running normally, “RUN” indicator will be lighted in green.

8.1.2 Description of Buttons

Table8-2 Buttons Function Table

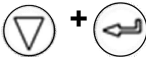
Buttons	Name	Functions
	“ON/OFF”	Press once to stop; long time press for 3s to get it started.
	“UP”	Page up and increase data. long time press for Continuous increase.
	“DOWN”	Page down and decrease data. long time press for Continuous reduction.
	“ENTER”	To choose and confirm.
	“DOWN+ENTER”	Return to main interface.



Note !

When inverter is powered on, LCD display background is lighted, and after 30s normal running, the background light turns off.

8.1.3 LCD Display Interface Overview

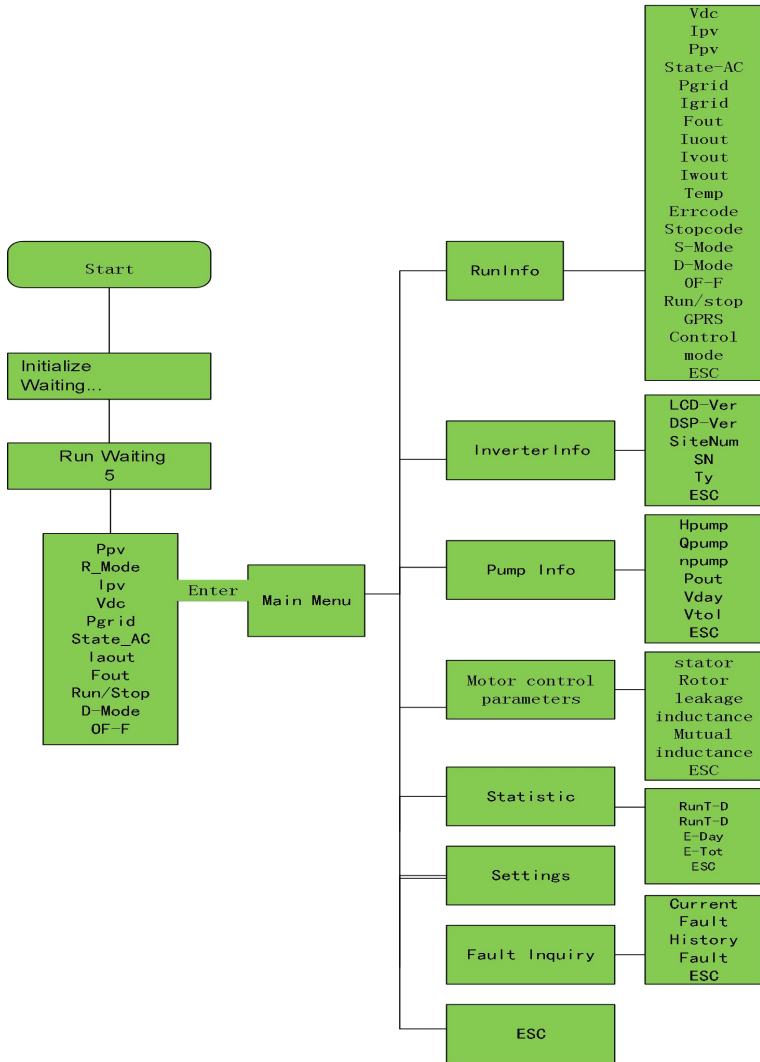

Figure8-2 LCD diagram (1)

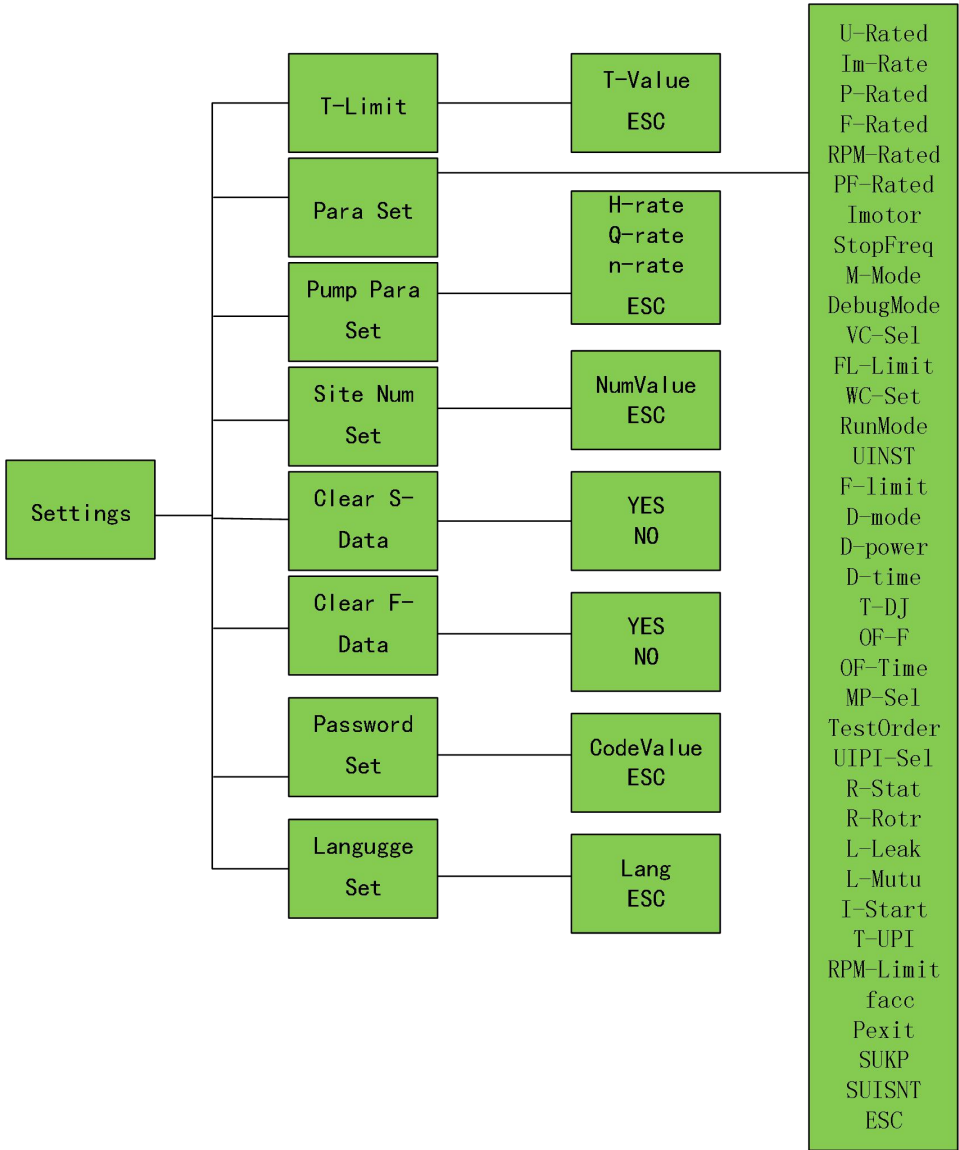

Figure8-3 LCD diagram (2)

8.2 Initial Operational Interface

Once the inverter power on, the system start to initialize, display the initialization interface:

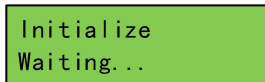

Figure8-4 System initialize

If the start-stop mode is auto., countdown interface will be display after initialization complete, and when countdown finished, LCD will enter the main interface, inverter will drive water pump. "RUN" indicator light.

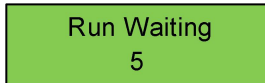

Figure8-5 Countdown interface

If the start-stop mode of the system is manual (factory default setting), long press the "ON/OFF" key for 3s, and the inverter will start up and run.



Note!

- The default mode of inverter is manual start-stop mode. When inverter power for the first time, it need key-press to start the inverter to drive pump.(Run after long-time press "ON/OFF"), at the same time, manual start-stop mode will change into automatic start-stop mode directly.
- Press "ON/OFF" stop the inverter and it will get started while long-time pressing "ON/OFF", if not do like this, the system won't start.
- The inverter can work at regular intervals, that is, the inverter automatically stops after the set working time. For details, please refer to "**8.3.2.1 Timing Shutdown Time Setting**" and "**8.3.4 Parameter**

Setting".

- The long button time described in this article is approximately 3 seconds.
- LCD display two lines of characters.

After inverter initializing, main interfaces will be displayed circularly:

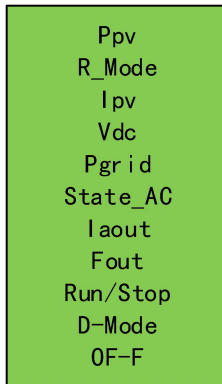

Figure8-6 Main interface

Main interface display basic running information. Main interface will turn page auto after 10s, or you can turn page through pressing "UP" and "DOWN" button.

8.3 System parameter query and setting

8.3.1 Query information item description

The query information items include main interface information, operation information, basic information, water pump information, statistical information, and fault information.

All query information items can be queried on the LCD display interface.

“Figure 8-2 LCD menu block diagram 1” lists the locations where all queried

information items are located.

The following describes the operation information, basic information, pump information, statistical information, and fault information.

8.3.1.1 operation information

The items in the operation information show the current operation information of the inverter. The following table explains each item in detail.

Figure8-3 The meaning of main interface parameters

RunInfo	Introduction
Vdc	Inverter input voltage (V).
Ipv	Inverter input current (A).
Ppv	Inverter input power (W).
State-AC	Current grid status of inverter (online/offline).
Pgrid	Inverter current grid input power, unit W.
Igrid	Inverter current grid input current (DC side), unit A.
Fout	Inverter output current frequency (Hz).
Iuout	Inverter output U phase current (A).
Ivout	Inverter output V phase current (A).
Iwout	Inverter output W phase current (A).
Temp	Inverter radiator temperature, unit °C.
Errcode	Inverter current fault code.
Stopcode	Stop code, can query the last stop code of the inverter, according to the stop code can query the cause of the inverter stop.
S-Mode	Automatic/manual start and stop mode.
D-Mode	Inverter dry mode detection/automatic
0F-F	Selection of water overflow alarm function in water storage device of photovoltaic water pump system.

Run/stop	Inverter operation/down state.
GPRS	Inverter GPRS connection state.
Control mode	Inverter operating mode
ESC	Back To Previous Menu

8.3.1.2 Basic Information

InverterInfo, shows basic information of inverter, please refer to the figure below.

Figure 8-4 Basic Information Details

Inverter Info	Explain
LCD-Ver	Version information of LCD program.
DSP-Ver	Version information of DSP program.
SiteNum	When the inverter selects RS485 communication, the network node number of the inverter is located.
SN	Series number of inverter.
Ty	Type of inverter.
ESC	Return to the previous menu

8.3.1.3 Pump Information

Pump information item show the basic information of pump.

Figure 8-5 Pump information description

Pump Info	Description	Remark
Hpump	Pump running lift head (m)	The rated head, rated flow and rated speed in the setting menu must be set first; otherwise, they all appear to

		be zero.
Q _{pump}	Pump current water flow (m ³ /h)	
n _{pump}	Pump current running speed (r/m)	
P _{out}	Pump current power (W)	
V _{day}	Pump daily water output on that day (m ³)	
V _{tol}	Pump total water output (m ³)	
ESC	Return to the previous menu	

8.3.1.4 Motor control parameters

Table 8-6 Motor control parameters

Motor control parameters	explain	remark
determinant	Stator resistance value R _s	
rotor	Rotor resistance R _r	
leakage inductance	The leakage inductance values of L ₀	
mutual inductance	Mutual inductance value L _m	

8.3.1.5 Statistic Information

Statistic Information, statistic of the totally running time and power generation

of inverter. Please refer to figure below

Table 8-7 Detailed statistic data

Statistic	Description
RunT-D	Inverter daily running duration. This figure will be reset when recharged.
RunT-T	Accumulative running duration..
E-Day	Daily power inverted. This figure will be reset when recharged.
E-Tot	Accumulative power inverted
ESC	Return to the previous menu

8.3.1.6 Fault Inquiry

Fault Inquiry, to inquiry current and historic malfunction.

Table8-8 Fault inquiry

Fault Inquiry	Explain
Current Fault	Current fault inquiry
History Fault	History fault inquiry
ESC	Return to the previous menu.

8.3.2 Setting information Item Description

Setting information items are all under the parameter setting menu, including setting of scheduled down time, DSP parameter setting, water pump information, site number setting, zero clearing point information, zero clearing fault information, password setting and language setting.

"Figure 8-2 LCD Menu Block Diagram 1" and "Figure 8-3 LCD menu block Diagram 2" list the parameter Settings and the locations of all settable information items under this menu. The following will give a detailed

introduction to each setting item.

8.3.2.1 Setting of regular stop time

This setting item is used to set the fixed stop time of the inverter, which is convenient for users to set according to their needs and make the inverter stop itself within the set time.

Table 8-9 Description of regular downtime setting

Timed shutdown information	Description	Note
Time	The inverter will stop automatically in minutes after reaching this time (Minutes).	

8.3.2.2 DSP parameter setting

Used for setting key parameters of solar pump inverter system.

Table 8-10 DESCRIPTION of DSP parameter setting

DSP Parameter Setting Information	Description	Note
U-Rated	Rated voltage of motor, unit is V. The setting principle is that the rated voltage is equal to the rated voltage indicated on the pump nameplate.	
Im-Rate	Motor rated current value, unit A. The setting principle is that the rated current is equal to the rated current value indicated on the pump nameplate.	

P-Rated	Rated power value of motor, unit is W. The setting principle is that the rated power is equal to the rated power value indicated on the pump nameplate.	
F-Rated	Rated frequency value of motor, unit is W. The setting principle is that the rated power is equal to the rated frequency value indicated on the pump nameplate.	
RPM-Rated	Rated speed value, in RPM. The setting principle is that the rated speed is equal to the rated speed indicated on the pump nameplate.	
PF-Rated	Rated power factor, unit is. The setting principle is that the rated power factor is equal to the rated power factor indicated on the pump nameplate.	
Imotor	Motor overload current protection value, refer to the water pump motor nameplate to set this parameter, it is recommended to be equal to 1.2 times the motor rated current value.	
StopFreq	Stop frequency value in Hz. The setting principle is that the shutdown frequency is approximately equal to the lowest output frequency of the inverter when the PV pump system is able to pump water.	
M-Mode	Select this option to control the forward or reverse of the motor. This parameter can be set if the pump water is abnormal during the first	

	debugging.	
DebugMode	<p>This value represents the operating mode of the inverter:</p> <p>=0, indicating that the inverter is in vector mode + reliable type</p> <p>=1, indicating that the inverter is in VF mode + reliable type</p> <p>=2, indicating that the inverter is in vector mode + economic mode</p> <p>=3, indicating that the inverter is in VF mode + economic mode</p> <p>=4, indicating that the inverter is in RC mode</p> <p>=5, indicating that the inverter is in the mode of distributed detection of motor parameters</p> <p>=6, indicating that the inverter is in the mode of continuously detecting motor parameters</p> <p>=8, indicates that the inverter is in theoretical calculation of PI parameters</p> <p>=9, indicating that the inverter is in group control mode</p> <p>=10, indicating that the inverter is in the ac current calibration mode</p>	
VC-Sel	<p>=0 full-order model;</p> <p>=1 voltage model;</p> <p>=2 Improved voltage model;</p> <p>=3 Improved full-order model;</p>	
FL-Limit	The flux limit of the motor.	

WC-Set	WC-Set	
RunMode	=CVT =MPPT	
UINST	The instruction voltage of the array, used for the operating voltage point of the instruction array.	CVT mode works
F-limit	Frequency limit, the maximum frequency that the inverter can output. the default value is "50Hz"or"60Hz"	
D-mode	When the user's PHOTOVOLTAIC water pump system adopts external water level sensor to realize the dry protection of the water pump, the dry protection mode shall be set to "test".	
D-power	When the user's photovoltaic pump inverter matches the pump with lower power, this parameter needs to be reset. The recommended setting is 40% of the rated power of the pump. For example, the drying power of 7.5KW water pump can be set to 3000.	
D-time	Beat dry recovery time. Under automatic beating mode: the interval time of starting and running of the inverter again after the inverter is stopped by beating alarm, the unit is minutes. The factory default is 30 minutes. Detection in the beating mode: the interval time (in minutes) between the inverter receiving the	

	beating recovery signal and the inverter starting and running again. The factory default is 30 minutes.	
T-DJ	Beat dry judge time, unit is S.	
OF-F	The inverter selects the overflow alarm function of the photovoltaic pump system. When the water level alarm function of the water storage device is used, it needs to enable this setting and set it as "on".	
OF-Time	The upoverflow protection recovery time, the interval time (in minutes) between the inverter receiving the upoverflow recovery signal and the inverter starting and running again. The factory default is 30 minutes.	
MP-Sel	=AUTO motor parameter automatic detection input; =Manual Motor parameters Manual input is valid.	
TestOrder	=1 Test stator resistance; =2 Test leakage sensation; =3 Test rotor resistance; =4 Test static mutual inductance; =5 Test dynamic mutual inductance; =6 Theoretical calculation of mutual inductance.	
UIPI-Sel	=AUTO motor PI parameter input automatically; =Manual Motor PI parameter Manual input is	

	valid.	
R-Stat	M Ω stator resistance, unit, used for motor control parameters.	
R-Rotr	M Ω rotor resistance, unit, used for motor control parameters.	
L-Leak	Motor leakage inductance, mH, used for motor control parameters.	
L-Mutu	Motor mutual inductance, mH, used for motor control parameters.	
I-Start	M Ω stator resistance, unit, used for motor control parameters.	
T-UPI	M Ω rotor resistance, unit, used for motor control parameters.	
RPM-Limit	Motor leakage inductance, mH, used for motor control parameters.	
facc	When the economic mode is chosen, when the operating frequency is lower than the access frequency, the power grid is connected to ensure the maximum power operation of the inverter. (This parameter setting value must be greater than the stop frequency)	
Pexit	When the economic model is selected, when the photovoltaic power is higher than the exit power, the power grid exit ensures that the inverter only USES photovoltaic energy. (This parameter setting is recommended to be about 75% of the load pump power, with the minimum	

	power change of 100W.)	
SUKP	The debugging mode is effective under "group control", adjusting slave KP.	
SUISNT	The debugging mode is effective under "group control" to adjust the slave instruction voltage.	
ESC	Back To Previous Menu	



Note !

When the user selects solar pump inverter, the parameters in the menu of "DSP Parameter Setting" have been set by factory, and these parameters cannot be changed easily.

- When the output selection is changed, the inverter must be powered off. It can only be started up again after the inverter is completely powered off. Otherwise, the inverter and water pump may be damaged.
- When the inverter output is switched from three-phase to single-phase, the commissioning mode must be changed from "0" to "4" to start up and run for the first time. If the single-phase output is switched to three-phase output, this step is not required.

8.3.2.3 Pump Information Setting

Used to set relevant parameters of water pump information.

Table 8-11 Description of water pump information setting (user sets according to water pump parameters)

Pump Information Setting	Description	Note
H_rate	Set pump rated lift head (m)	According to pump nameplate input Settings
Q_rate	Set pump rated water flow (m ³ /h)	
n_rate	Set pump rated speed (r/m)	

8.3.2.4 Site Number Set

SiteNum Set, for remote RS485 communication use. Please refer to the figure below.

Table 8-12 SiteNum Set Description

Site Number Set	Description	Note
SiteNum	Inverter network site number	The maximum value is 64.

8.3.2.5 Statistical Data Clear

Clear S-Data, to clear inverter’s total running time and cumulative output power.

Table 8-13 Statistical Data Clear Description

Clear generation info.	Description	Note

Yes	Choose yes,clear the information of the inverter output power	
No	Return to the previous menu.	

8.3.2.6. Historical Malfunction Clear

Clear F-Data, to clear historical malfunction record.

Table 8-14 Historical malfunction clear information description

Historical Malfunction Clear	Description	Note
Yes	The option is to immediately clear the inverter historical Fault.	
No	Return to the previous menu.	

8.3.2.7. Password Setting

Password Setting, to set the password to enter set menu.

Table 8-15 Password setting description

Password set	Description	Note
New Password	Set the password to enter the Settings menu.	The default initial value for a two-digit password is 00, and the maximum value can be set to 99.

8.3.2.8. Language Setting

Language setting, to set the man-machine interface language category.

Table 8-16 Language set description

Language set	Description	Note
Chinese	After confirming the setting, the LCD display language of the inverter is set to Chinese.	
English	After confirming the setting, the LCD display language of the inverter is set to English.	

8.3.2.9 Display time setting

Time setting, LCD display time setting, used to correct LCD display time.

Table 8-17 Inverter time setting list.

Time	Explain
Year	Adjust LCD display year
Month	Adjust LCD display month
Date	Adjust LCD display date
Hour	Adjust LCD display hour
Minute	Adjust LCD display minute
ESC	Return to the previous menu.



8.3.3 Information inquiry

In the main interface, press the up and down keys to directly query the information displayed in the main interface, and press the "ENTER" key to

ENTER the main menu, to query the detailed parameters of the inverter, and to set some parameters and functions.

The inquiry operation is shown here using the inquiry fault code as an example.

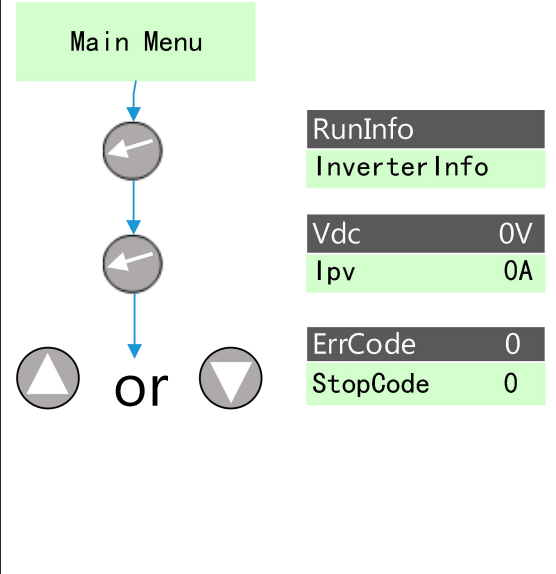
- 1) Firstly, located the "fault code" : According to the "Figure 8-2 LCD menu Block Diagram 1", the fault code is under the operation Information menu;
- 2) "Operation information" is the inquiry information item. The specific inquiry operation is as follows

Keys operation and LCD display	Description
	<ol style="list-style-type: none"> 1. LCD is the main interface after startup; 2. Press  to enter the main menu, and the cursor falls on the operation information item; 3. Press  to enter the operation information item for query; 4. Press the up or down key

to move the cursor and find the fault code.



Note!

All query information items can be inquired according to the above operation, and the fault information in the operation information is only illustrated here. Please refer to "**8.3.1 Description of Inquiry Information Item**" for introduction of inquiry information item.

8.3.4 Parameter Setting

Enter the correct password before entering the parameter setting interface.

After entering the parameter setting menu, you can set the configurable information items given in "**8.3.2 Setting Information Item Description**".

Here, the setting operation is demonstrated only with the example of "D-power Setting".

1) Position "D-power Setting": According to the block Diagram of "Figure 8-2 LCD Menu", "D-power Setting" is in the "Parameter Setting" menu;

2) "D-power Setting" is the setting information item. The specific setting steps are as follows:

Keys operation and LCD display	Description
<p>The diagram illustrates the navigation sequence on the LCD display:</p> <ul style="list-style-type: none"> Main Menu (highlighted) Press to move the cursor to the right. Press or to navigate between menu items. The LCD displays RunInfo (highlighted) and Inverter Info. Press to move the cursor to the left. The LCD displays Settings (highlighted) and Fault Inquiry. Press to move the cursor to the left. The LCD displays Password ** and ESC (highlighted). 	<ol style="list-style-type: none"> 1. Press on the main interface to enter the main menu, and the cursor falls on the operation information item; 2. Press the up key or down key to find the parameter setting item; 3. Press to enter parameter setting. Enter the correct two-digit password. <p>* The initial default password is 00.</p>

Password *0
ESC

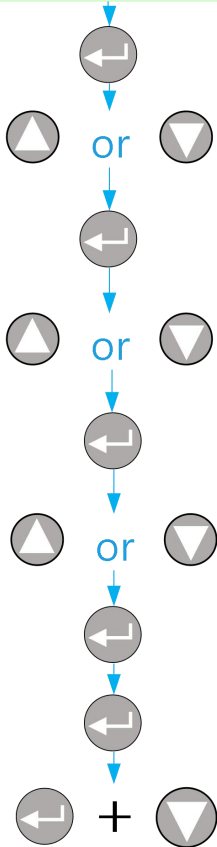

T-Limit
Para Set

T-Limit
Para Set

Imotor 0A
D-Power 0W

Imotor 0A
D-Power 300W

YES
NO

Imotor 0A
D-Power 300W

Ppv 0W
R_Mode MPPT

1. Enter the correct password to enter the setting menu, and the cursor falls on the timed downtime item;



2. Press  to select the setting item of D-power;

3. After entering the D-power setting, set the D-power according to the confirmation;

4. Press the up key or down key to switch the power size of drying and modify the step size to 100W;

5. Select the power to be set and confirm again whether to replace the power after confirmation;

6. Select "Yes" and set the dry power, as shown in the left picture. Set the D-power from 0 to 300W;

7. Press  and  to return to the main menu.



Note!

All information items given in **"8.3.3 Setting Information Item Description"** can be set according to the above operation, which is explained here only by taking the setting of D-power as an example.

8.4 Malfunction Description

If communication failure appears, the below interface will appear.

Comm Error

This interface will appear, and Fault red led flickers to show malfunction, this means internal communication malfunction is appear.

Fault: 2
Fault105

Display show malfunction, fault LED lights up, shows inverter malfunction or stop. Press "UP" or "DOWN" to inquire current malfunction, choose "ESC", press "ENTER" to quit. (When LCD screen show fault code, and fault LED lights up, which mean inverter fault or stop. Press "UP" or "DOWN" to inquire current fault, choose "ESC", press "ENTER" to quit.)

**Note !**

Malfunction manual reset function: when the machine breakdown with malfunction, can long press "ON/OFF" button, the machine can automatically restart immediately. When the machine is displayed Fault112, no such reset function.

The following table shows the possible fault codes and status names of the inverter.

Table 8-17 Fault codes and status names

LCD displays fault code and status code	Name of malfunction and condition
Fault 100	Drive over current fault
State 101	PV Array under voltage
Fault 102	Bus over-voltage
Fault 103	Retention (bus equalizing fault)
Fault 104	Radiator over heating
Fault 105	Output over-load
Fault 106	Array over-voltage
Fault 107	Array over-current
Fault 108	Inverter AC Output over-current
State109	Dry alarm
State110	Weak sunshine
Fault 111	Temperature sensor fault
Fault 112	Short circuit fault (Nonrecoverable)

Fault 113	Initialization error from the machine
State 114	Overflow alarm
Fault 115	Output phase lose
Fault 200	Stator detection fails
Fault 201	Rotor detection failure
Fault 202	Leakage detection failed
Fault 203	Mutual inductance failed
Fault 204	The main control is disconnected with the small LIQUID crystal
Fault 205	The grid is overcurrent
Fault 206	Bus voltage undervoltage
Fault 207	Power grid phase failure

9 Malfunction and Troubleshooting

9.1 Troubleshooting

Once malfunction or stop condition appears, the malfunction LED will lighten up, LCD will display current malfunction or stop condition, current malfunction will be recorded by the system for later inquire. Please refer to the form below which covers the fault and troubleshooting.

Table9-1 Shutdown status and troubleshooting

Condition code	Condition Name	Phenomena	Cause value	Troubleshooting
State 100	Drive over current fault	When the inverter stops, the system can start itself after the fault disappears.	Short circuit of inverter output cable; The inverter hardware circuit is damaged.	Please check whether there is short circuit between the inverter's three-phase output lines.
State 101	PV Array undervoltage	Inverter shutdown when the fault appeared and will automatically restart after it disappear.	Out put energy from array changes.	Please check the input voltage from array and make sure this voltage inside inverter input voltage range. Note: In cloudy days, morning, or

				down, this situation is not malfunction.
State 106	Array over-voltage	When the inverter stops, the system can start itself after the fault disappears.	The input voltage of dc side of inverter is higher than the maximum input voltage of inverter	Check the photovoltaic array maximum output open circuit voltage to ensure that this voltage value is lower than the inverter maximum input voltage.
State 107	Array flow	When the inverter stops, the system can start itself after the fault disappears.	The inverter hardware circuit is damaged.	Please contact Supplier Technology LTD.
State108	Inverse current overcurrent	1. When the inverter stops, the system can start itself	The power of pump motor is greater than the rated	1, check whether the pump motor power More than the rated power of the

		<p>after the failure disappears;</p> <p>2. During the first debugging, the machine starts up with inverter overcurrent, and the output current is large with a small frequency.</p>	<p>power of inverter. Blocked or damaged water pump motor;</p> <p>The construction of pipeline system does not meet the operation standard of water pump;</p> <p>The stator resistance and mutual inductance values are too large when the motor parameters are detected.</p>	<p>inverter, if it is necessary to replace the inverter and pump, so that they keep the same;</p> <p>Check whether the pump motor is blocked or damaged;</p> <p>Check whether the piping system matches the pump;</p>
--	--	---	---	---

State 109	Dry alarm	Inverter shut down until the water level recover or protection recover time is up, the machine will restart automatically.	Water level of source is lower than low-level water level sensor, even lower than inlet of pump.	<ol style="list-style-type: none"> 1. Please check the water level, if the water level is ok, please check if there are air inside pump. 2. Please check the position of water level sensor.
State 110	Weak sunshine	Inverter shutdown. When malfunction disappear, inverter can restart automatic.	Array output low.	Usually appears in early morning, dusk and cloudy days. This situation is aim to protect the motor of pump and lengthen the lifetime.
State 111	TEMP SENSOR FAIL	The inverter shuts down.	The temperature sensor installed in the system machine is not connected	Please contact Supplier Technology LTD.

			or damaged.	
State 114	Overflow alarm	Inverter shut down until the water level recover or protection recover time is up, the machine will restart automatically.	Water level in container higher than high-end level sensor.	If this situation appears more than once, please check onsite and set the water level sensor at a proper height.
State 115	The output phase	When the inverter stops, the system can start itself after the fault disappears.	One or two phase output cable of the inverter is not well connected to the motor.	Please check whether the connection part of three-phase output line is reliable.

Condition code	Condition Name	Phenomena	Cause value	Troubleshooting
Fault200	Stator detection fails	unable to boot	1. The inverter and the motor are not well connected; 2. Motor damage; 3. Internal failure of the machine.	1. Check whether the connection between the motor and the inverter is short or open and whether the output air opening is closed; 2. Check whether the motor is damaged; 3. Please contact the supplier.
Fault201	Rotor detection failure	Unable to boot		
Fault202	Leakage detection failed	Unable to boot		
Fault203	Mutual inductance failed	Unable to boot		
Fault204	The main control is disconnected with the small LIQUID crystal	Unable to boot	1. The connection cable between LCD and main control becomes loose and falls off; 2. Equipment	1. Check the connection between LIQUID crystal and control board; 2. Contact suppliers;

			hardware failure;	
Fault205	The grid is overcurrent	When the inverter stops, the system can start itself after the shutdown state disappears.	1. Short circuit or blocked turn of the pump; 2. Hardware failure	1. Check the wiring of the water pump and whether the water pump can work normally; 2. Check whether the output of the inverter is normal.
Fault206	Bus voltage undervoltage	When the inverter stops, the system can start itself after the shutdown state disappears.	The grid voltage is too low, or the array voltage is too low, or the hardware fails.	Disconnect the power grid and photovoltaic input switch to ensure no voltage input to the inverter. Check the power grid voltage and photovoltaic voltage with a multimeter respectively.

Fault 207	Power grid phase failure	When the inverter stops, the system can start itself after the shutdown state disappears.	The output cable of one or two phases of the power grid is not well connected with the inverter. Loose wiring in the power grid.	Disconnect the power grid and photovoltaic input switch to ensure no voltage input of inverter, and check the wiring condition of the input side of the power grid.
-----------	--------------------------	---	--	---

9.2 Maintenance

Please check and ensure the inverter is not charged with electricity before any maintenance.

A routine examination must be done every half year:

- Check the inverter for damaged or with deformation.
- Check whether there is abnormal noise when inverter is running.
- Check whether the parameters and time settings are correct.

Every half to one year, a routine examination should be done:



Warning!

Please check and make sure the inverter is not charged with electricity before any maintain work below.

- Check humidity and dust of inverter surrounding environment, if have too

much dust, clean the inverter.

- Check the inverter cable connection is loose, if loose, tightening again according to the connection method of wire.
- Check whether the cable is damaged, especially the metal surface contact surface is cut marks or not.

9.3 Contact Customer Service

In order to provide faster and better service, please provide us with information below:

- Model of Inverter
- Series number of inverter
- Malfunction name and time

10 Appendix A

Technical Data

Item \ Model	JNP22KH-V5	JNP30KH-V5	JNP37KH-V5
DC input			
Max. input DC voltage	880Vdc		
Recommended MPPT voltage	460~850Vdc		
Max. input DC current	49A	67A	82A
MPPT efficiency	>99%		
AC input			
AC input voltage range	360~460Vac (3PH)		
AC input voltage frequency	50Hz/60Hz		
AC output			
Max. applicable motor output power	22kW	30kW	37kW
Rated output voltage	380~460Vac (3PH)		
Output frequency range	0~50/60Hz		
Rated output current	42A	57A	71A

Mechanical data		
Weight	IP65	
Item \ Model	-25~60°C	
type of cooling	forced air cooling	
Max. input DC voltage	LCD	
Recommended MPPT voltage	RS485/GPRS	
Max. input DC current	3000m, Operation of downgrading over 3000 meters	
MPPT efficiency	<60dB	
AC input	EN 50178; IEC/EN 62109-1;IEC61800	
AC input voltage range	460*715*260(mm)	
AC input voltage frequency	44kg	
Item \ Model	JNP45KH-V5	JNP55KH-V5
DC input		
Max. input DC voltage	880Vdc	
Recommended MPPT voltage	460~850Vdc	
Max. input DC current	100A	122A
MPPT efficiency	>99%	
AC input		
AC input voltage range	360~460Vac (3PH)	

AC input voltage frequency	50Hz/60Hz	
AC output		
Max. applicable motor output power	45kW	55KW
Rated output voltage	380~460Vac (3PH)	
Output frequency range	0~50/60Hz	
Rated output current	86A	104A
Mechanical data		
Weight	IP65	
Item \ Model	-25~60°C	
type of cooling	forced air cooling	
Max. input DC voltage	LCD	
Recommended MPPT voltage	RS485/GPRS	
Max. input DC current	3000m, Operation of downgrading over 3000 meters	
MPPT efficiency	<60dB	
AC input	EN 50178; IEC/EN 62109-1;IEC61800	
AC input voltage range	460*715*260(mm)	
AC input voltage frequency	44kg	

11 Appendix B

11.1 Quality Assurance

The product malfunction in the warranty period, Supplier be free to repair or replace products. The warranty period take the contract as a standard.

Evidence

During the warranty period, customers should provide the invoices for the purchase of products and date. And the trademarks of the products should be clearly visible. Otherwise we do have the right not to assume quality assurance.

Conditions

- The replaced products should be returned to supplier.
- Supplier should be given reasonable time to repair the malfunctioning equipment.

Exemption from liability

The company has the right not to carry out quality assurance in the following:

- Transport damage
- Incorrect installation, modification and usage.
- Overall, components have been beyond the warranty period.
- Bad operating environment beyond the descriptions in this manual.
- Non company services, personnel to repair, replacement or demolition cause machine damage.
- Damage caused by abnormal natural environment.

If the product size and parameters have changed, the latest information given

by the company shall prevail without notice.

11.2 Contact Us

If you have any question about Solar Pump Inverter, please contact Supplier.